

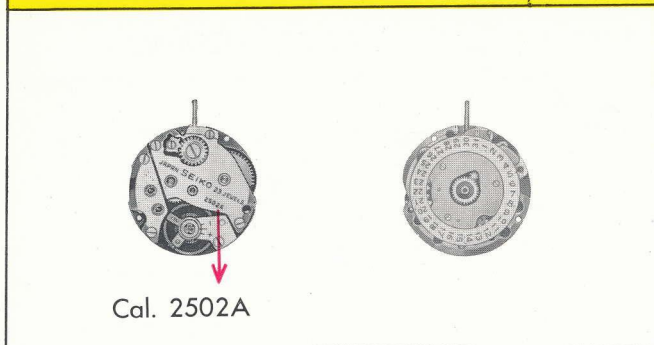

Seiko 2502A Movement Parts (1)

Compiled by EmmyWatch - <https://www.emmywatch.com>



























Calibre No. <h2 style="text-align: center;">2502A</h2>	Jewels <h2 style="text-align: center;">17j 23j</h2>	Style Name <h2 style="text-align: center;">(Chorus Calendar Special)</h2>
⇨ Basic Calibre 2519A 23J Catalog No. 25-19-1		







Characteristics

Casing diameter : 17.20 φmm
 Maximum height : 3.50 mm
 Vibrations per hour : 19,800
 Non-automatic with sweep second
 Calendar (date)
 "Diashock" Shock Resistant Device
 "Diafix" Oil Lubrication Device

EMMYWATCH
 VINTAGE RESTORATIONS

								
111252 (for 17j)	111253 (for 23j)	122251	141251 (for 17j) 141258 (for 23j)	171250	224250	225250	231252	241250 (for 17j)
								
241251 (for 23j)	245250	251250 (for 17j) 251252 (for 23j)	310250	261250	271250	383251	387250	443120
								
488250	453250	476120	556330	☆ 801250	802330	808250	810250	811250

				$\frac{2}{1}$
012251	012717	012718	390251	

☆ ⇨ Please see remarks on the reverse page.

As for all other parts not shown here, please refer to the basic calibre

(Cal. No. **2519A** 23j Catalog No. 25-19-1 Red page).

Calibre No.	2502A	Jewels	Style Name
		17j 23j	(Chorus Calendar Special)
⇒ Basic Calibre	2519A 23j Catalog No. 25-19-1		

PART NO.	LIST OF MATERIALS	PART NO.	LIST OF MATERIALS
111252	Barrel bridge (for 17j)	491180	Dial washer
111253	Barrel bridge (for 23j)	014413	Diashock upper frame
122251	Center wheel bridge	014414	Diashock lower frame
141251	Fourth wheel bridge (for 17j)	014415	Diashock hole jewel with frame
141258	Fourth wheel bridge (for 23j)	011212	Diashock cap jewel
161250	Pallet cock	014417	Diashock spring
171250	Balance cock	015241	Diafix upper hole jewel with frame for 4th wheel (for 23j)
205250	Complete barrel with arbor	015221	Diafix upper hole jewel with frame for escape wheel (for 23j)
213251	Barrel arbor	011204	Diafix cap jewel (for 23j)
224250	Center wheel & pinion with cannon pinion	015213	Diafix spring (for 23j)
225250	Cannon pinion	556330	Date finger
231252	Third wheel & pinion	☆ 801250	Date dial
241250	Fourth wheel & pinion (for 17j)	802330	Date driving wheel
241251	Fourth wheel & pinion (for 23j)	808250	Date dial guard
245250	Sweep second pinion	810250	Date jumper
251250	Escape wheel & pinion (for 17j)	811250	Date jumper spring
251252	Escape wheel & pinion (for 23j)	012118	Barrel bridge screw, short
261250	Minute wheel	012118	Fourth wheel bridge screw
271250	Hour wheel	012118	Balance cock screw
281250	Setting wheel	012120	Dial screw
282250	Clutch wheel	012121	Stud screw
283250	Winding pinion	012204	Pallet cock screw
284250	Crown wheel	012251	Center wheel bridge screw
285250	Ratchet wheel	012252	Barrel bridge screw, long
301250	Jewelled pallet fork & staff	012407	Case screw
310250	Balance complete with stud	012501	Crown wheel screw
315250	Balance staff	012642	Click screw
331180	Roller with jewel	012701	Lower end-piece screw for escape wheel (for 23j)
341250	Regulator	012717	Date dial guard screw
345250	Stud holder	012718	Minute wheel bridge screw
351251	Winding stem	012718	Setting lever spring screw
372250	Joint stem (movement portion)	011132	Upper hole jewel for center wheel
373250	Joint stem (case portion)	011118	Lower hole jewel for center wheel
381250	Click	011513	Lower hole jewel for 3rd wheel (for 23j)
382030	Click spring	011513	Lower hole jewel for 4th wheel (for 23j)
383251	Setting lever	011710	Lower hole jewel for sweep second pinion
384250	Yoke (Clutch lever)	011402	Lower hole jewel for escape wheel (for 17j)
385250	Yoke spring (Clutch lever spring)	011610	Lower hole jewel for escape wheel (for 23j)
387250	Minute wheel bridge	011505	Upper hole jewel for pallet
388250	Setting lever spring	011505	Lower hole jewel for pallet
390251	Setting lever axle	011110	Hole jewel for minute wheel (for 23j)
401250	Mainspring (self-greasing)	013004	Tube for bridge screw, long
443120	Upper hole jewel with frame for 3rd wheel	013113	Tube for bridge screw, short
443120	Upper hole jewel with frame for 4th wheel (for 17j)		
453250	Upper hole jewel with frame for escape wheel (for 17j)		
476120	Lower end-piece for escape wheel (for 23j)		
481250	Crown wheel ring		
488250	Upper hole jewel with frame for sweep second pinion		

Remarks :

Date dial

☆ 801250 Used when both the crown and the date frame are located at 3 o'clock.
If the date dial of this calibre is required in any other type, specify ① Cal. No. ② the date frame position.

☆ ⇨ Please see remarks.

Items in light letters are not shown in photos; those parts are interchangeable with the basic calibre

(Cal. No. **2519A** 23j Catalog No. 25-19-1 Red page).