



























Omega 3301 Movement Parts (2)

Compiled by EmmyWatch - <https://www.emmywatch.com>



























Spare Parts list for Calibre 3301

Second wheel	Version	Reference	Shock-absorber, lower	Version	Reference
	3301A	722330330027**		3301A	722330332062
	3301B			3301B	7223303B70531
Escape wheel	Version	Reference	In settings, upper	Version	Reference
	3301A	722330330040		3301A	7223303A32127
	3301B			3301B	7223313B32127
Ratchet wheel	Version	Reference	In settings, lower	Version	Reference
	3301A	722330331022		3301A	7223303A32167
	3301B			3301B	7223313B32167
Crown wheel	Version	Reference	Cap jewel, lower	Version	Reference
	3301A	722330331023		3301A	7223303A32262
	3301B			3301B	
Minute wheel	Version	Reference	Cap jewel, upper	Version	Reference
	3301A	722330331041S2		3301A	7223303A32325
	3301B			3301B	
Hour wheel	Version	Reference	Shock-absorber spring, top	Version	Reference
	3301A	722330331046**		3301A	7223303A32425
	3301B			3301B	
Cannon pinion with driving wheel	Version	Reference	Shock-absorber spring, bottom	Version	Reference
	3301A	722330331080**		3301A	7223303A32462
	3301B			3301B	
Motion work setting wheel	Version	Reference	Ratchet wheel driving wheel	Version	Reference
	3301A	722330331102		3301A	72233033203301
	3301B			3301B	
Winding pinion	Version	Reference	Wig-wag pinion	Version	Reference
	3301A	722330331120		3301A	722330332104
	3301B			3301B	
Sliding pinion	Version	Reference	Stop pinion	Version	Reference
	3301A	722330331121		3301A	722330332105
	3301B			3301B	
Reduction wheel	Version	Reference	Intermediate date wheel	Version	Reference
	3301A	722330332031S2		3301A	722330333011
	3301B			3301B	
Shock-absorber, upper	Version	Reference	Date indicator driving wheel	Version	Reference
	3301A	722330332025		3301A	722330333020
	3301B	7223313B32027		3301B	

Spare Parts list for Calibre 3301

Date corrector intermediate setting wheel 1	Version	Reference	Yoke	Version	Reference
	3301A	7223303A33082		3301A	722330351050
	3301B			3301B	
Date corrector intermediate setting wheel 2	Version	Reference	Rocking bar	Version	Reference
	3301A	722330333083		3301A	722330351052
	3301B			3301B	
Chronograph wheel	Version	Reference	Setting lever	Version	Reference
	3301A	722330335010**		3301A	722330351083
	3301B			3301B	
Minute-counting wheel	Version	Reference	Setting lever jumper	Version	Reference
	3301A	722330335012**		3301A	722330351090
	3301B			3301B	
Hour-counting wheel	Version	Reference	Click	Version	Reference
	3301A	722330335030**		3301A	722330351120
	3301B			3301B	
Driving wheel for counters	Version	Reference	Stop click	Version	Reference
	3301A	722330335031		3301A	722330352053
	3301B			3301B	
Hour counter additional driving wheel 1	Version	Reference	Date jumper	Version	Reference
	3301A	722330335032		3301A	722330353080
	3301B			3301B	
Hour counter additional driving wheel 2	Version	Reference	Date corrector	Version	Reference
	3301A	722330335033		3301A	722330353200
	3301B			3301B	
Pallet fork	Version	Reference	Column wheel operating lever	Version	Reference
	3301A	722330340010		3301A	722330355040
	3301B			3301B	
Balance complete with stud	Version	Reference	Hammer operating lever	Version	Reference
	3301A	722330340055		3301A	7223303A55048
	3301B	7223303B40055		3301B	
Stud support	Version	Reference	Clutch rocker	Version	Reference
	3301A	722330340210		3301A	722330355090
	3301B			3301B	
Winding stem	Version	Reference	Clutch lever	Version	Reference
	3301A	722330351010		3301A	722330355100
	3301B			3301B	

Spare Parts list for Calibre 3301

Column wheel jumper	Version	Reference	Hour wheel friction spring	Version	Reference
	3301A	722330355130		3301A	722330366220
	3301B				
Minute counter jumper	Version	Reference	Crown wheel core	Version	Reference
	3301A	722330355143		3301A	7223303881136
	3301B				
Chronograph column-wheel	Version	Reference	Dial fastener	Version	Reference
	3301A	722330355180		3301A	722330370200
	3301B				
Chronograph and minute hammer	Version	Reference	Date indicator	Version	Reference
	3301A	722330355240		3301A	722330391440*
	3301B				
Hour hammer	Version	Reference	Screw for stud	Version	Reference
	3301A	722330355248		3301A	72233034002
	3301B				
Eccentric screw	Version	Reference	Screw for automatic device bridge	Version	Reference
	3301A	722330355445		3301A	722330360003
	3301B				
Balance stop lever	Version	Reference	Screw for hammer operating lever	Version	Reference
	3301A	722330356070		3301A	72226016004
	3301B				
Click spring	Version	Reference	Screw for clutch rocker	Version	Reference
	3301A	722330361080		3301A	72226016004
	3301B				
Yoke spring	Version	Reference	Screw for clutch lever	Version	Reference
	3301A	722330361100		3301A	72226016004
	3301B				
Stop click spring	Version	Reference	Screw for Column wheel jumper	Version	Reference
	3301A	722330362101		3301A	72226016004
	3301B				
Date jumper spring	Version	Reference	Screw for Minute counter jumper	Version	Reference
	3301A	722330363030		3301A	72226016004
	3301B				
Column wheel operating lever spring	Version	Reference	Screw for barrel bridge	Version	Reference
	3301A	722330365040		3301A	72233036011
	3301B				
Hammer operating lever spring	Version	Reference	Screw for Hammer operating lever spring	Version	Reference
	3301A	722330365047		3301A	7223612A6012
	3301B				

Spare Parts list for Calibre 3301















Screw for ratchet wheel	Version	Reference	Screw for setting lever jumper	Version	Reference
	3301A	72233036019		3301A	72233037035
	3301B			3301B	
Screw for column wheel operating lever	Version	Reference	Screw for oscillating weight	Version	Reference
	3301A	72233036022		3301A	72233038200
	3301B			3301B	
Screw for Hammer operating limitation bridge	Version	Reference	Screw for pallet bridge	Version	Reference
	3301A	72233036034		3301A	72233038204
	3301B			3301B	
Screw for column wheel operating lever	Version	Reference			
	3301A	72233036204			
	3301B				
Screw for crown boss	Version	Reference			
	3301A	72233036204			
	3301B				
Screw for date indicator maintaining plate	Version	Reference			
	3301A	72233036210			
	3301B				
Screw for Setting lever jumper	Version	Reference			
	3301A	72233036407			
	3301B				
Screw for click	Version	Reference			
	3301A	72233037008			
	3301B				
Screw for chronograph bridge	Version	Reference			
	3301A	72233037031			
	3301B				
Screw for balance-bridge	Version	Reference			
	3301A	72233037031			
	3301B				
Screw for train wheel bridge	Version	Reference			
	3301A	72233037031			
	3301B				
Screw for barrel bridge	Version	Reference			
	3301A	72233037031			
	3301B				
Screw for chronograph bridge	Version	Reference			
	3301A	72233037033			
	3301B				
Screw for automatic device bridge	Version	Reference			
	3301A	72233037033			
	3301B				

Fig. 1.0a

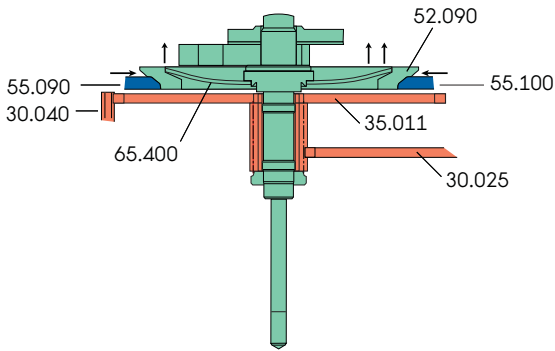
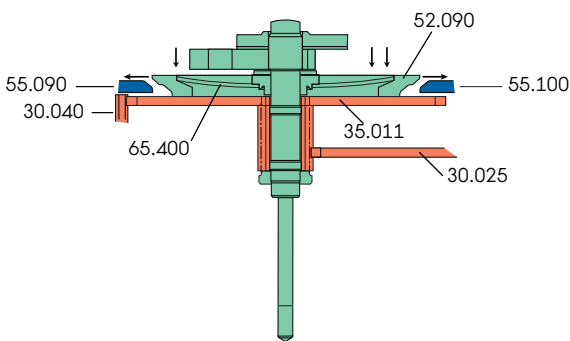

Fig. 1.0b



1.0 Chronograph wheel function

Chronograph wheel 35.010*

Chronograph wheel 35.010* is equipped with a coupling system by which the chronograph can be coupled with and uncoupled from the movement's gear-train.

Do not clean

Chronograph wheel (35.010*):

The chronograph wheel can only be lubricated during the manufacturing process. Cleaning damages the lubrication and could leave cleaning solution residue at the chronograph wheel, which interferes with operating and timing.

Chronograph stoppage position

In chronograph stoppage position, clutch disc 52.090 is raised following clamping by clutch rocker 55.090 and clutch lever 55.100, thus avoiding contact with chronograph pinion 35.011 which is constantly coupled with the movement's gear-train.

Chronograph operating position

In chronograph operating position, clutch disc 52.090 is released simultaneously by clutch rocker 55.090 and clutch lever 55.100. Pushed by chronograph wheel friction spring 65.400, it comes to rest on chronograph pinion 35.011 which will drive it in its travel.

EMMYWATCH
VINTAGE RESTORATIONS

1.1 Description of chronograph system

Fig. 1.1

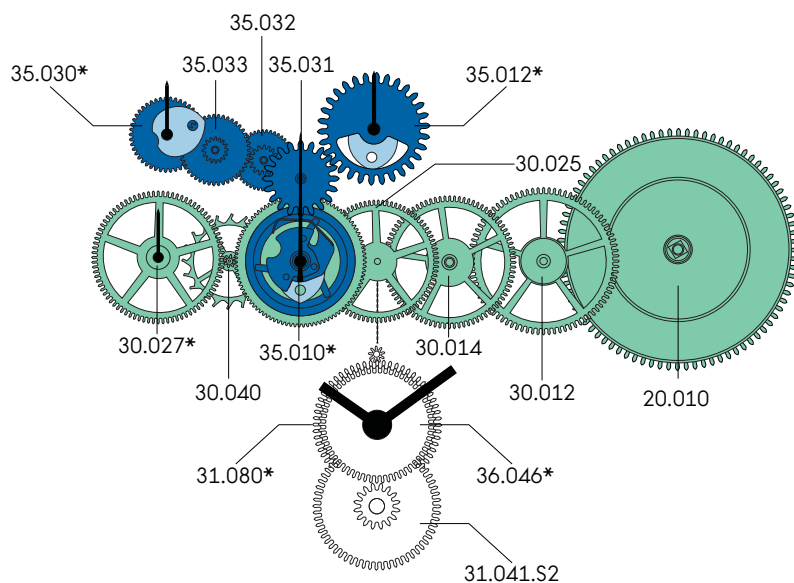
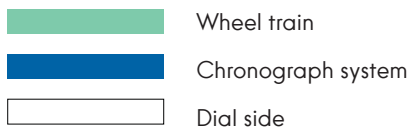

2.0 Chronograph setting

Fig. 2.1

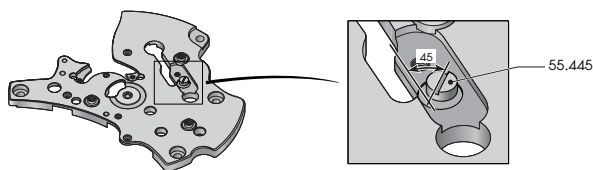

2.1 Check on the eccentric screw for the counter jumper (55.445)

The eccentric screw (55.445) of the counter jumper (55.143) must be positioned as in the drawing. The slot of the eccentric screw (55.445) must form an angle of 45° in relation to the recess in the bridge. An additional correction is subsequently possible when the chronograph is being set. Do not forget to place the hour hammer (55.248) under the bridge and lubricate it.

Fig. 2.2

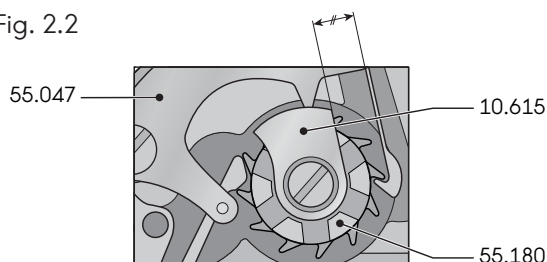

2.2 Hammer-lever banking bridge (10.615)

The hammer-lever banking bridge (10.615) prevents the hammer operating lever (55.047) from moving into an unsuitable position. It should be positioned above the hammer operating lever (55.047) and its straight flank should be parallel to the hammer operating lever spring (65.047).

Fig. 2.3

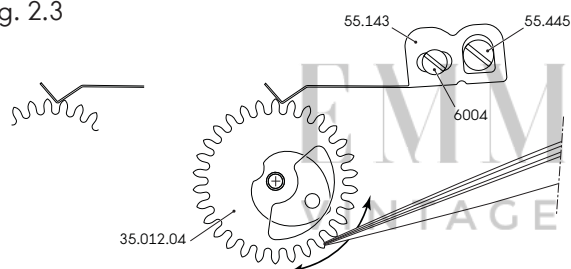

2.3 Check on position of minute counter (35.012*)

Place the chronograph in reset position. Using a plastic or brass point, move the minute counter (35.012*) slightly to the left and right. It is important that the minute counter should return correctly to its original position. With the eccentric screw (55.445), the position of the counter jumper (55.143) can be corrected.

Fig. 2.4 - Drawing 1

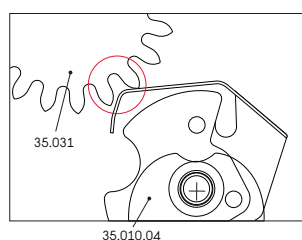
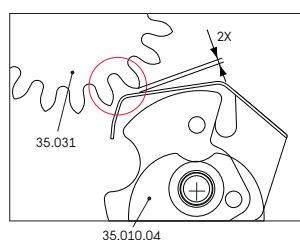

Fig. 2.4 - Drawing 2



2.4 Check on location of chronograph finger in reset position

Check the location of the chronograph finger in reset position. To ensure good synchronisation between the second counter and the minute counter, the chronograph finger should be between the position of «slight contact against the tooth» (see drawing 1) and a maximum distance of twice the thickness of the finger blade (see drawing 2).

Fig. 2.5

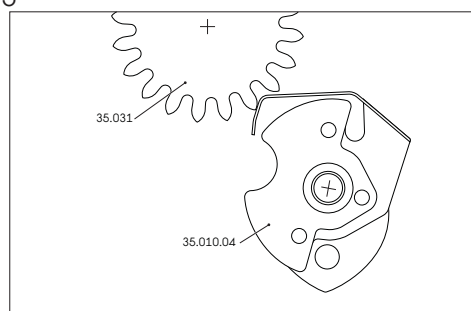

2.5 Chronograph finger operating safety

Put the chronograph in START position. Check that the minute counter jump is operating correctly by checking the penetration of the chronograph finger.

2.6 Checking the minute jump

In the START position, drive the chronograph hand with a brass or plastic point until the minute jumps. The difference in relation to the position of the chronograph's seconds hand in the zero setting position has a tolerance of 2/5 second. Check the function of the counter jumper (55.143) on the hand.

3.0 Runners for hand setting and hand setting force









Description	Movement holder for hand setting	No. of runners for hand setting	Minimum force (N)	Maximum force (N)	Support (jewel)
Hour hand	507 0001	6	10	50	No
Minute hand		2	10	50	No
Chrono second hand in the centre		1	40	60	Yes
Second hand (small)		1	10	40	Yes
Hour counter hand		1	25	50	Yes
Minute counter hand		1	25	50	Yes

4.0 Epilame coating

4.1 Partial epilame coating

Description	Reference	
Pallet fork **	40010	

4.2 Components that should not be epilam-trearede after cleaning

Description	Reference	
Balance fitted on balance bridge	40055 + 10058°	
In setting, upper *	32127	
In setting, lower *	32167	
Pallet bridge	10057	
Barrel****	20010	
Slipping mainspring	20100	
Hour-counting wheel	35030*	
Chronograph wheel ***	35010*	

* Do not treat the shock-absorber settings with epilam; the cap jewels should however be treated.

** Pallet fork: Steep only the two gathering pallets in epilame.

*** Do not clean the chronograph wheel.

**** Do not treat the complete barrel with epilam, only the drum, cover and arbour separately.

For additional information see Working Instructions No 27.

5.0 Instantaneous rate

5.1 Check of the instantaneous rate

Demagnetise the movement before the checks according to Working Instruction 34.

The rate can be checked with a Witschi Watch Expert or a similar apparatus capable of acoustic measurements. The lift angle has to be set to 51 degrees.

The timing of the movement has to be according to the Omega timing specification list.

Please consult Working Instructions 5 and 28 for instructions and tolerances.

Fig. 5.2

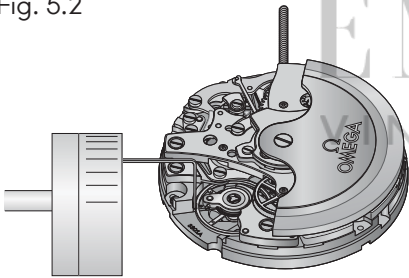

5.2 Rate adjustment

A special timing key tool has been developed to adjust the rate even when the movement is cased in (see Fig. 5.3). The rate can be corrected according to the table below by turning the two balance screws a complete turn. A scale is found on the outside of the tool. A division corresponds to a rate correction of 1 second. (according to the table below). One screw is located between two arms on the balance which are specially marked by points (see Fig. 5.4) for easy identification of each screw during the correction process.

Fig. 5.3

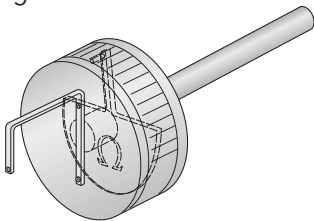

REF. 502 200 0501

Fig. 5.4

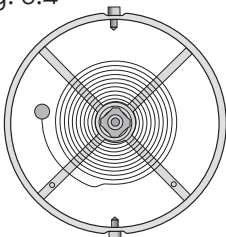

Balance

The annular balance has two adjusting micro-screws. A slow rate deviation is corrected by tightening the micro-screws (towards the centre of the balance), which reduces its moment of inertia and makes it run faster. A fast rate deviation is corrected by loosening the micro-screws (away from the centre of the balance). This increases its moment of inertia and makes it run slower.

Important:

The rate is always corrected using both adjustment screws to prevent an unbalance of the balance.

Versions A & B identical
One correction revolution = 57 seconds
One graduation = 1 second



Modifications of Technical Guide versions for Calibre 3301

Technical Guide versions				
First version:	23.03.2006	Version A	Made by:	Pelrom
Second version:	01.04.2006	Version B		Rendav
Last version:	12.09.2008	Version C		

Modifications of Technical Guide version B	
Old version (A)	New version (B)
Tool for checking escapement functions Ref. 506 0002 / Page 4	Tool for checking escapement functions Ref. 506 0004 / Page 4
	Additional drawing of barrel reversed / Page 7
	Additional lubricant point on column wheel on exploded view / Page 8

Modifications of Technical Guide version C	
Old version (B)	New version (C)
	Update of exploded views Update of the lubrication points Diverse Information

EMMY WATCH

VINTAGE RESTORATIONS

